

ROLLING GARAGE GATES

GUARD

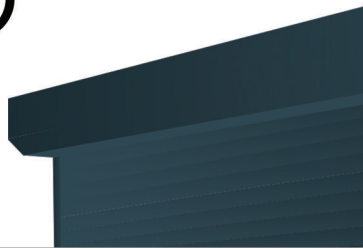

INTENSE

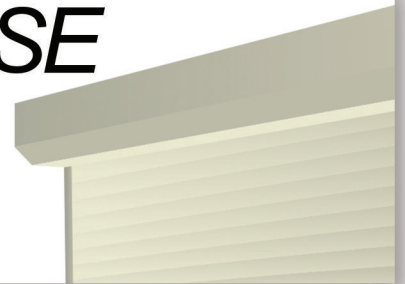

MINI 52

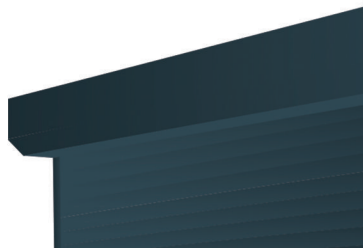

MINI 55

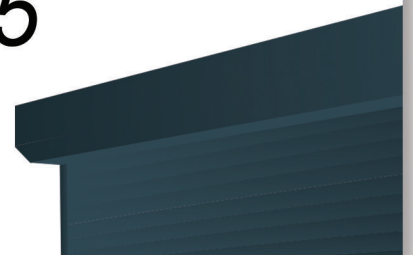

ROLLER DOOR GARAGE

GUARD

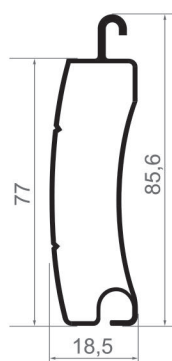
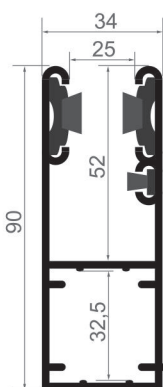
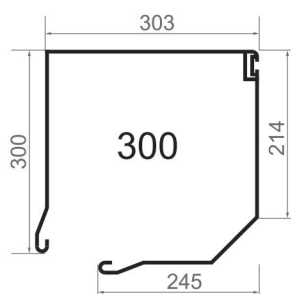
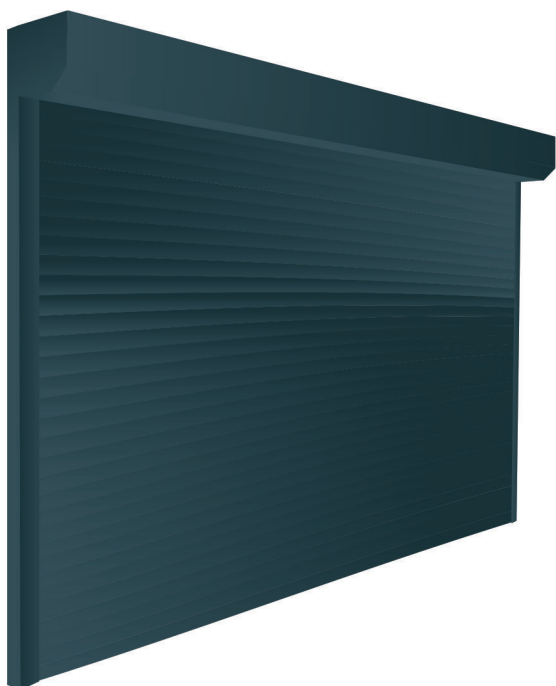

SPECIFICATIONS

Maximum width	450 cm
Maximum height	320 cm
Maximum area	14,4 m ²
Aluminium cover box	30 cm
Aluminium sides	30 cm
Aluminium guides	9 cm
Insulated aluminium profile	T 77
EasyLook profile	SFP-S
Ventilation profile	LP-R 77
Profile height	7.7 cm
Profile thickness	1.8 cm
Armouring weight	5,5 kg/m ²

COLOURS	1 white	2 cream white	3 ivory
	4 light beige	5 golden oak	6 walnut
	7 light brown	8 jamaica brown	9 light grey
	10 silver	11 charcoal	12 black
	13 fir	14 moss green	15 purple red

Presented colours are for reference purposes only and can be slightly different from the actual colour of the product



ROLLING SHUTTER

INTENSE

SPECIFICATIONS

Maximum width

9 cm aluminium guides	450 cm
15 cm aluminium guides	540 cm
10 cm aluminium guides + wind hooks	600 cm

Maximum height

30 cm aluminium cover box	320 cm
30 cm aluminium cover box for door width over 450 cm	300 cm
36 cm aluminium cover box	450 cm
58 cm steel brackets	600 cm

Maximum gate area	32 m ²
Aluminium sides	30 cm
Steel sides	36 cm
Insulated aluminium profile	T77
EasyLook profile	SFP-5
Ventilation profile	LP-R 77
Profile height	7.7 cm
Profile thickness	1.8 cm
Armouring weight	5,5 kg/m ²

COLOURS	1	2	3
	white	cream white	ivory
	4	5	6
	light beige	golden oak	walnut
7	8	9	10
light brown	jamaica brown	light grey	silver
11	12	13	14
charcoal	black	fir	moss green
15			
			purple red

* 36 cm cover box and 15 cm guides not available in this colour.

Presented colours are for reference purposes only and can be slightly different from the actual colour of the product

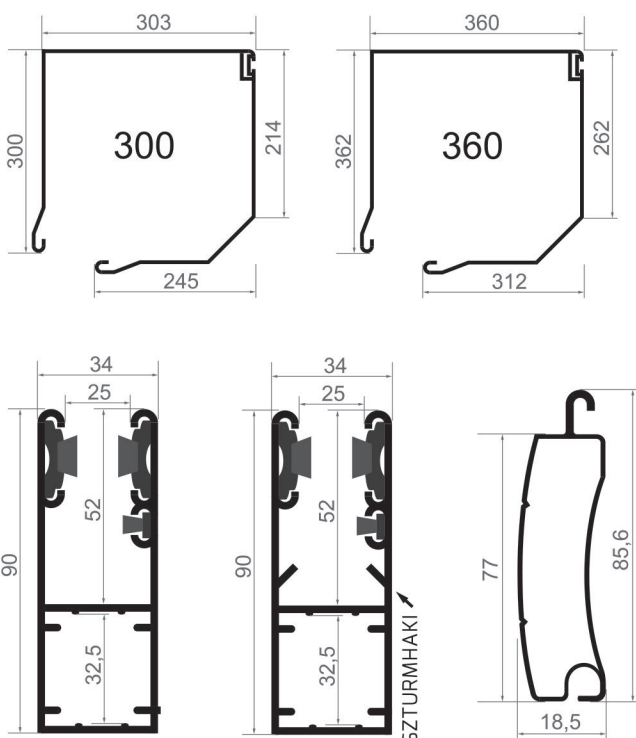



IN STANDARD



PROFILE

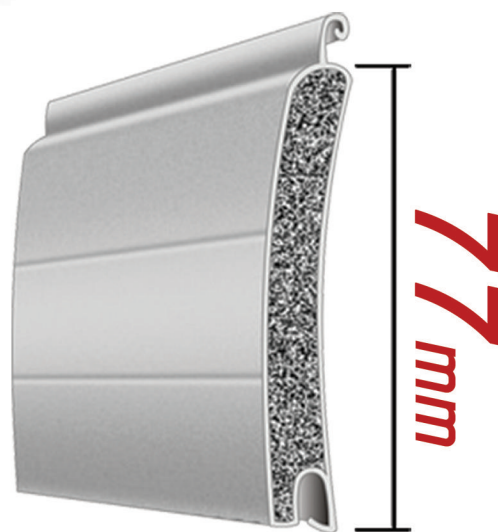

OUR GATES STAND OUT DUE TO THE HEIGHT OF THE ARMOUR **77mm** WHICH IS A STANDARD

ROLLING GATE



SPECIFICATIONS

Maximum width:	320 cm
Maximum height:	
Aluminum box 20.5 cm:	250 cm
Aluminum box 25.4 cm:	380 cm
Maximum area:	9 m ²
Extruded aluminum:	6,6 cm
Pro fi l aluminum insulated:	52
Profile height:	5,2
Profile thickness:	1,3 cm
Curtain weight:	3,1 kg/m ²

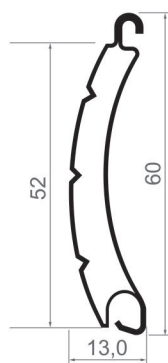
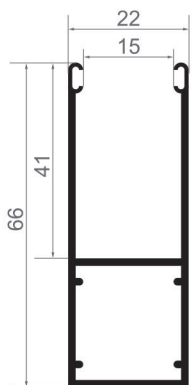
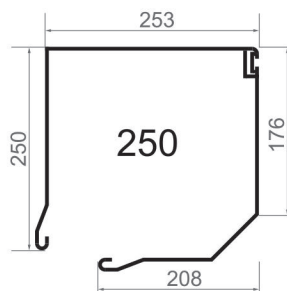
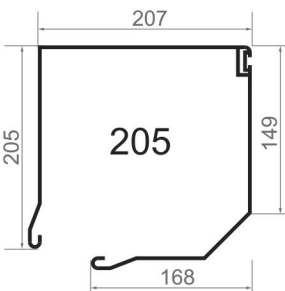

COLORS	1 WHITE	2 CREAMY WHITE	3 IVORY
	4 LIGHT BEIGE	5 GOLDEN OAK*	6 NUT*
	7 LIGHT BROWN	8 BROWN JAMAICAN	9 LIGHT GREY
	10 SILVER	11 ANTHRACITE GRAY	

* BOX AND GUIDES SURCHARGE
THE COLORS ARE FOR ILLUSTRATION
AND MAY DIFFER SLIGHTLY FROM THE ACTUAL.



ROLLING GATE



SPECIFICATIONS

Maximum width:	320 cm
Maximum height:	
Aluminum box 20.5 cm:	250 cm
Aluminum box 25.4 cm:	380 cm
Maximum area:	9 m ²
Extruded aluminum:	6,6 cm
Pro fi l aluminum insulated:	52
Profile height:	5,2
Profile thickness:	1,3 cm
Curtain weight:	3,1 kg/m ²

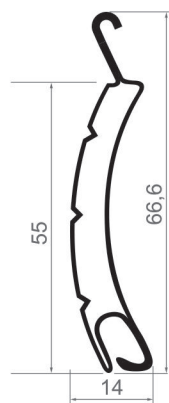
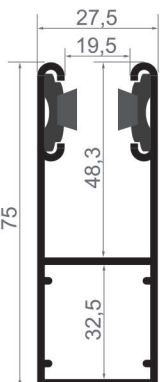
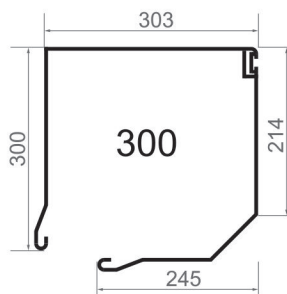
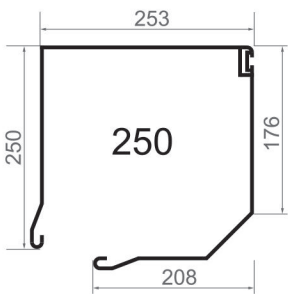
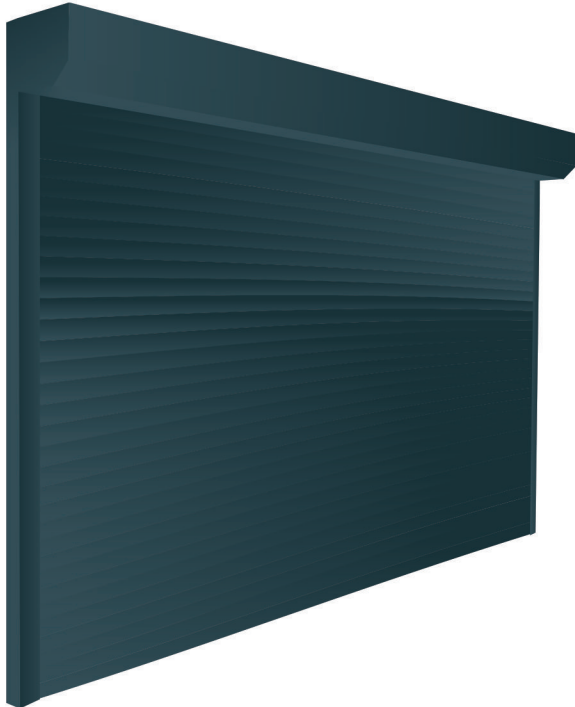

COLORS	1 WHITE	2 CREAMY WHITE	3 IVORY
	4 LIGHT BEIGE	5 GOLDEN OAK*	6 NUT*
	7 LIGHT BROWN	8 BROWN JAMAICAN	9 LIGHT GREY
	10 SILVER	11 ANTHRACITE GRAY	

* BOX AND GUIDES SURCHARGE
THE COLORS ARE FOR ILLUSTRATION
AND MAY DIFFER SLIGHTLY FROM THE ACTUAL.





IN STANDARD



PROFILE

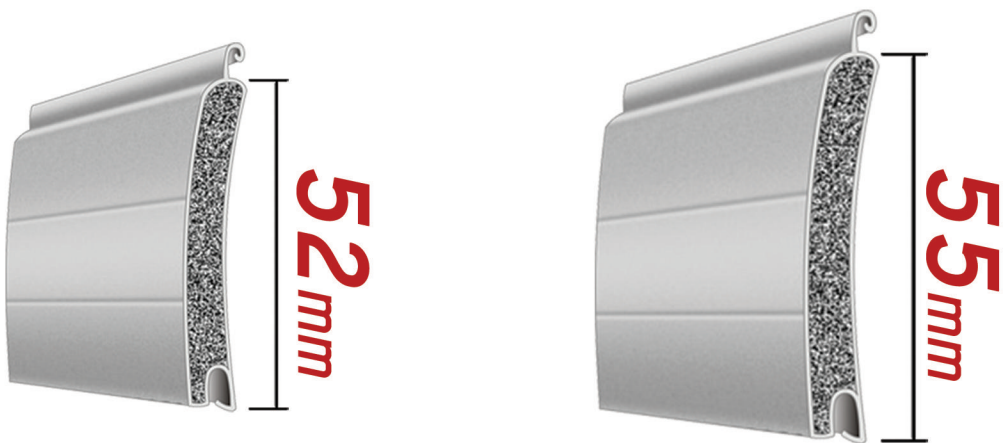

OUR GATES STAND OUT DUE TO THE HEIGHT OF THE ARMOUR **52mm or 55mm**



MOUNTING OPTIONS

VARIANT 1

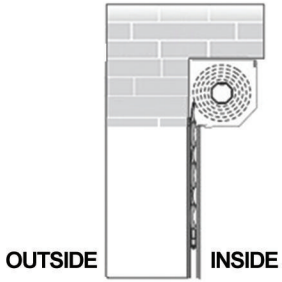

VARIANT 2

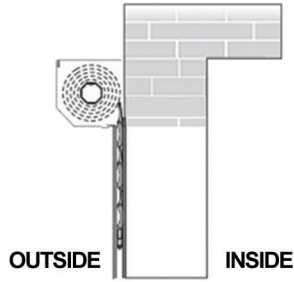

VARIANT 3

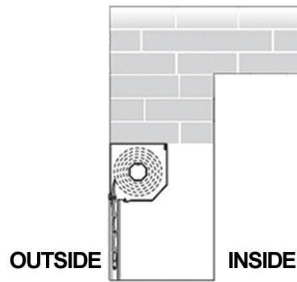

VARIANT 4

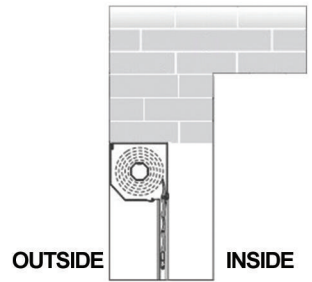

ENGINE POSITION FROM THE SIDE OF THE CARTRIDGE (INDOORS)

LEFT

RIGHTS

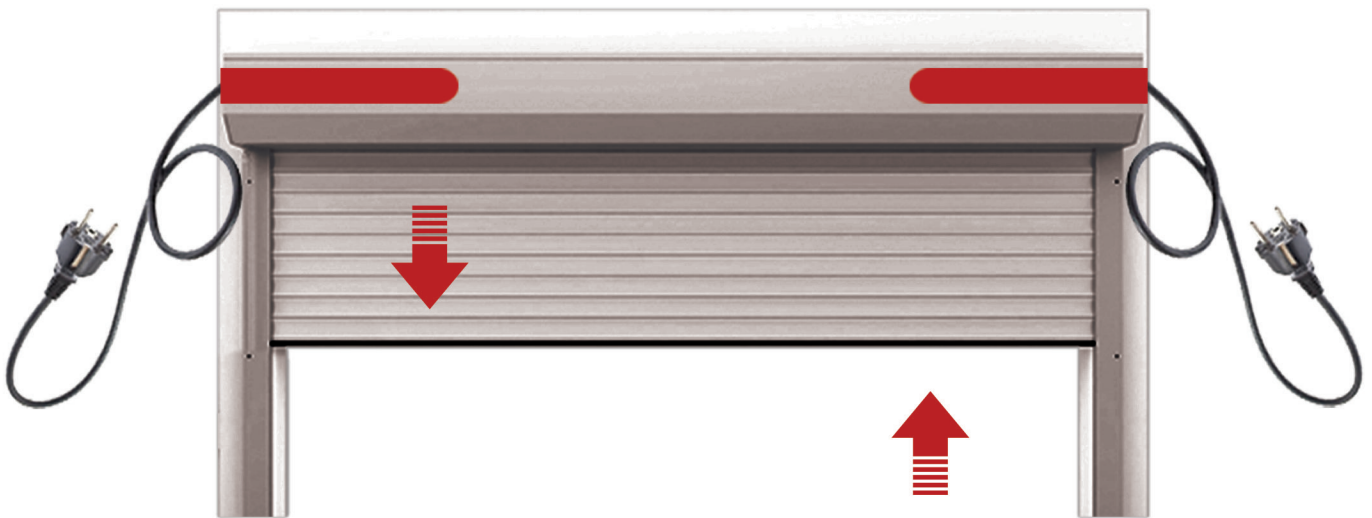

IN THE PRODUCTION OF OUR GATES WE USE THE BEST GERMAN PROFILES "ALUKON"



THANKS TO THE USE OF PROFESSIONAL AUTOMATICS "KRAFTMASTER" OUR GATES LAST LONG YEARS



HIGH QUALITY COMPONENTS „ELERO“ ARE SATISFACTION OF OUR CLIENT

YOU WILL RECEIVE GRATIS

**ROLLER AND HANGER PROTECTIVE RUBBERS
LOCKS PREVENTING SCRATCHING THE GATE LABEL FROM THE INSIDE**





THE INSTRUCTION OF USING SEGMENTED GATE

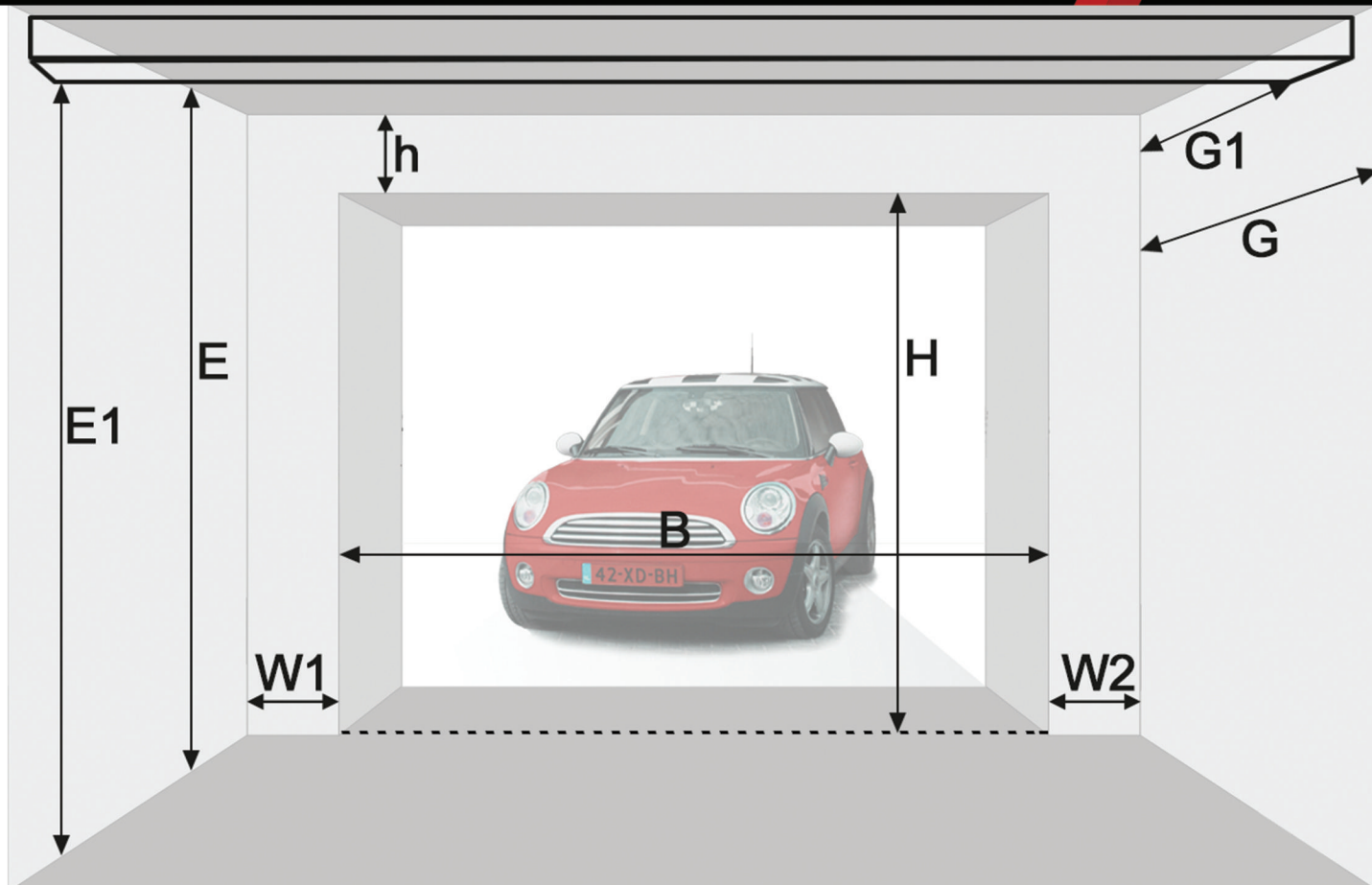

B - WIDTH OF OPENING
H - HIGHT OF OPENING
h - LINTEL
W1 - JAMB
W2 - JAMB
S - THE LEVEL OF CAR LIGHTS
AFTER GATE INSTALLATION ($S < H$)

E - THE HIGHT
OF THE GARAGE
E1 - THE HIGHT OF
THE GARAGE FROM THE BARRIER
G - THE DEPTH
OF THE GARAGE
G1 - THE DEPTH OF
THE GARAGE FROM THE BARRIER



SOMFY CONTROL SYSTEM

DOUBLE DUCT REMOTE CONTROL

FOUR DUCT REMOTE CONTROL

FOUR DUCT REMOTE CONTROL ATTACHED TO THE KEY RING

DOUBLE- DUCT ON-THE-WALL TRANSMITTER

RADIO CODE KEYBOARD

PHOTOCELL SET

WARNING LAMP WITH AN ANTENNA

CONTROL SYSTEM KRAFTMASTER

SWITCHBOARDS

KRAFTMASTER ECOLINE ++2 1 CHANNEL REMOTE CONTROLS

KRAFTMASTER PROLINE +2 2 CHANNEL REMOTE CONTROLS

KRAFTMASTER PROLINE +2 2 CHANNEL REMOTE CONTROLS

REMOTE CONTROLS

PHOTOCELLS

PILOT ECOLINE/PROLINE 3 CHANNEL REMOTE CONTROL

PILOT PROLINE 4 CHANNEL REMOTE CONTROL

PHOTOCELL PROLINE

ELECTRIC CONNECTORS

KEYS

DIRECTORY

IMPULSE

UNDER THE PLASTER

ON THE PLASTER

UNDER THE PLASTER

ON THE PLASTER

KEY

DIRECTORY

IMPULSE

UNDER THE PLASTER

ON THE PLASTER

UNDER THE PLASTER

ON THE PLASTER

INDUSTRIAL CONNECTOR IP65



DUAL CONTROLLER FOR 2 CONNECTORS



EXTRAS

INERTIAL BRAKE

KARDAN JOINT 90



LOCK HANGERS

WINCH PORT SAFETY LOCK



KDIRECT WINCH 75cm

WINCH WITH HOOK 150cm



AIR CONDITIONING PROFILE

EASYLOOK PROFILE WITH TRANSPARENT BAR



ANT- FREEZE PREPARATION

ANTIFREEZE





SEE THE GALERY OF OUR PRODUCTS

